



330

Hydraulic Excavator

Technical Specifications

Configurations and features may vary by region. Please consult your Cat® dealer for availability in your area.

Table of Contents

Specifications	2
Engine	2
Swing Mechanism	2
Weights	2
Track	2
Drive	2
Hydraulic System	2
Service Refill Capacities	2
Standards	2
Sound Performance	2
Operating Weights and Ground Pressures	3
Major Component Weights	3
Dimensions	4
Working Ranges and Forces	5
Reach Boom Lift Capacities	6
Bucket Specifications and Compatibility	9
Attachments Offering Guide	10
Standard and Optional Equipment	12
Dealer Installed Kits and Attachments	15
330 Environmental Declaration	16

330 Hydraulic Excavator Specifications

Engine

Engine Model	Cat® C7.1	
Net Power		
ISO 9249	203.7 kW	273 hp
ISO 9249 (DIN)	277 hp (metric)	
Engine Power		
ISO 14396	205 kW	275 hp
ISO 14396 (DIN)	279 hp (metric)	
Bore	105 mm	4 in
Stroke	135 mm	5 in
Displacement	7.01 L	428 in ³
Biodiesel capability	Up to B20 ⁽¹⁾	

- Meets U.S. EPA Tier 4 Final, EU Stage V, Korea Stage V, and Japan 2014 emission standards.
- Recommended for use up to 4500 m (14,760 ft) altitude with engine power derate above 3000 m (9,840 ft).
- Advertised power is tested per the specified standard in effect at the time of manufacture.
- Net power advertised is the power available at the flywheel when the engine is equipped with fan, air intake system, exhaust system and alternator.
- Engine speed at 2,200 rpm.

⁽¹⁾Cat diesel engines are required to use ULSD (ultra-low sulfur diesel fuel with 15 ppm of sulfur or less) or ULSD blended with the following lower-carbon intensity fuels** up to:

- ✓ 20% biodiesel FAME (fatty acid methyl ester)*
- ✓ 100% renewable diesel, HVO (hydrogenated vegetable oil) and GTL (gas-to-liquid) fuels

Refer to guidelines for successful application. Please consult your Cat dealer or “Caterpillar Machine Fluids Recommendations” (SEBU6250) for details.

**Engines with no aftertreatment devices can use higher blends, up to 100% biodiesel (for use of blends higher than 20% biodiesel, consult your Cat dealer).*

***Tailpipe greenhouse gas emissions from lower-carbon intensity fuels are essentially the same as traditional fuels.*

Swing Mechanism

Swing Speed	11.5 rpm	
Maximum Swing Torque	110 kN·m	81,132 lbf·ft

Weights

Operating Weight – 600 mm (24") Triple Grouser Shoes	30 400 kg	67,000 lb
--	-----------	-----------

- Long undercarriage, Reach boom, R3.2 m (10'6") stick, Heavy Duty (HD) 1.76 m³ (2.30 yd³) bucket, 600 mm (24") triple grouser shoes and 6700 kg (14,770 lb) counterweight.

Track

Standard Track Shoes Width	600 mm	24 in
Optional Track Shoes Width	700 mm	28 in
Number of Shoes (each side)	50	
Number of Track Rollers (each side)	9	
Number of Carrier Rollers (each side)	2	

Drive

Gradeability	35°/70%	
Maximum Travel Speed	5.3 km/h	3.3 mph
Maximum Drawbar Pull	248 kN	55,753 lbf

Hydraulic System

Main System – Maximum Flow – Implement	560 L/min (280 × 2 pumps)	148 gal/min (74 × 2 pumps)
Maximum Pressure – Equipment – Normal	35 000 kPa	5,075 psi
Maximum Pressure – Equipment – Heavy Lift Mode/Auto Dig Boost	38 000 kPa	5,510 psi
Maximum Pressure – Travel	35 000 kPa	5,075 psi
Maximum Pressure – Swing	29 800 kPa	4,320 psi
Boom Cylinder – Bore	140 mm	6 in
Boom Cylinder – Stroke	1407 mm	55 in
Stick Cylinder – Bore	150 mm	6 in
Stick Cylinder – Stroke	1646 mm	65 in
Bucket Cylinder – Bore	135 mm	5 in
Bucket Cylinder – Stroke	1156 mm	46 in

Service Refill Capacities

Fuel Tank Capacity	474 L	125.2 gal
Cooling System	25 L	6.6 gal
Engine Oil	25 L	6.6 gal
Swing Drive	10 L	2.6 gal
Final Drive (each)	5.5 L	1.5 gal
Hydraulic System (including tank)	310 L	81.9 gal
Hydraulic Tank	147 L	38.8 gal
Diesel Exhaust Fluid (DEF) Tank	41 L	10.8 gal

Standards

Brakes	ISO 10265:2008
Cab/Rollover Protective Structure (ROPS)	ISO 12117-2:2008
Operator Protective Guards (OPG) (optional)	ISO 10262-2:1998 Level II

Sound Performance

ISO 6395:2008 (external)	103 dB(A)
ISO 6396:2008 (inside cab)	70 dB(A)

- Hearing protection may be needed when operating with an open operator station and cab (when not properly maintained or doors/windows open) for extended periods or in a noisy environment.

330 Hydraulic Excavator Specifications

Operating Weights and Ground Pressures

	600 mm (24") Triple Grouser Shoes		600 mm (24") Double Grouser Shoes		700 mm (28") HD Triple Grouser Shoes	
	Weight	Ground Pressure	Weight	Ground Pressure	Weight	Ground Pressure
	kg (lb)	kPa (psi)	kg (lb)	kPa (psi)	kg (lb)	kPa (psi)
Base Machine Configurations						
Base Frame with Track Rollers and Carrier Rollers						
6700 kg (14,770 lb) Counterweight + Long Undercarriage Base Machine						
Reach Boom + R3.2CB2 (10'6") Stick + 1.76 m ³ (2.30 yd ³) HD Bucket	30 400 (67,000)	58 (8.4)	30 800 (67,900)	59 (8.5)	31 000 (68,400)	51 (7.3)
Reach Boom + R2.65CB2 (8'8") Stick + 1.76 m ³ (2.30 yd ³) HD Bucket	30 300 (66,800)	58 (8.4)	30 700 (67,700)	58 (8.5)	30 900 (68,100)	50 (7.3)

All operating weights include a 90% fuel tank with 75 kg (165 lb) operator.

Major Component Weights

	kg	lb
Base machine (6700 kg [14,770 lb] counterweight, upper frame, long undercarriage with HD rollers and two boom cylinders) – does not include weight of 90% fuel tank and 75 kg (165 lb) operator.	21 200	46,700
Track Shoes:		
600 mm (24") Width, 11 mm (0.43") Thick, Triple Grouser Track Shoes	3620	7,980
600 mm (24") Width, 14.5 mm (0.57") Thick, Double Grouser Track Shoes	3960	8,730
700 mm (28") Width, 13 mm (0.51") Thick, HD Triple Grouser Track Shoes	4200	9,260
Two Boom Cylinders	490	1,080
Weight of 90% Fuel Tank and 75 kg (165 lb) Operator	460	1,010
Counterweight:		
6700 kg (14,770 lb) Counterweight	6700	14,770
Undercarriage (without track shoes):		
Long Undercarriage with HD Rollers	6700	14,800
Boom (including lines, pins, stick cylinder):		
Reach Boom 6.15 m (20'2")	2310	5,090
Sticks (including lines, pins, bucket cylinder, bucket linkage):		
Reach Stick R3.2CB2 (10'6")	1470	3,240
Reach Stick R2.65CB2 (8'8")	1370	3,020
Buckets (without linkage, with tips and sidecutters):		
1.76 m ³ (2.30 yd ³) General Duty (GD), CB Linkage	1090	2,400
1.76 m ³ (2.30 yd ³) HD, CB Linkage	1350	2,980
Quick Couplers (QC):		
Pin Grabber QC CB with Pins	530	1,170
Pin Grabber QC CB without Pins	500	1,100
Dedicated QC	430	950

330 Hydraulic Excavator Specifications

Dimensions

All dimensions are approximate and may vary depending on bucket selection.

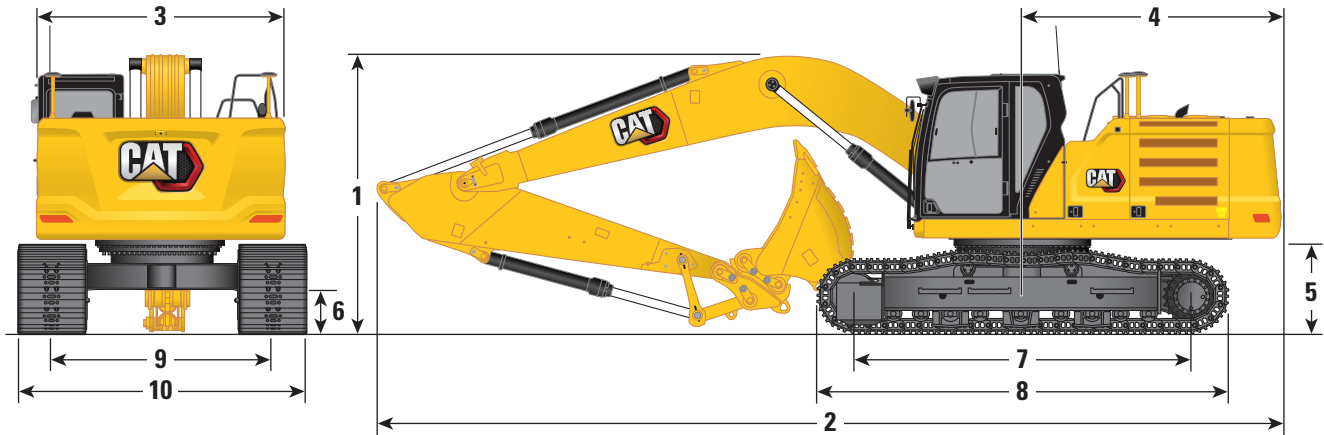

Boom Option

Reach Boom
6.15 m (20'2")

Stick Options

Reach Stick

R3.2CB2 (10'6")

R2.65CB2 (8'8")

	R3.2CB2 (10'6")		R2.65CB2 (8'8")	
1 Machine Height:				
Cab Height	3060 mm	10'0"	3060 mm	10'0"
Top of Global Navigation Satellite System (GNSS) Antenna Height (if installed)	3080 mm	10'1"	3080 mm	10'1"
OPG Height	3200 mm	10'6"	3200 mm	10'6"
Handrail Height	3060 mm	10'0"	3060 mm	10'0"
With Boom/Stick/Bucket Installed	3400 mm	11'2"	3450 mm	11'4"
With Boom/Stick Installed	3380 mm	11'1"	3380 mm	11'1"
With Boom Installed	3060 mm	10'0"	3060 mm	10'0"
2 Machine Length:				
With Boom/Stick/Bucket Installed	10 420 mm	34'2"	10 420 mm	34'2"
With Boom/Stick Installed	10 420 mm	34'2"	10 420 mm	34'2"
With Boom Installed	9230 mm	30'3"	9230 mm	30'3"
3 Upperframe Width	2940 mm	9'8"	2940 mm	9'8"
4 Tail Swing Radius	3130 mm	10'3"	3130 mm	10'3"
5 Counterweight Clearance	1120 mm	3'8"	1120 mm	3'8"
6 Ground Clearance	490 mm	1'7"	490 mm	1'7"
7 Length to Center of Rollers	3990 mm	13'1"	3990 mm	13'1"
8 Track Length	4860 mm	15'11"	4860 mm	15'11"
9 Track Gauge	2590 mm	8'6"	2590 mm	8'6"
10 Undercarriage Width				
600 mm (24") Shoes	3190 mm	10'6"	3190 mm	10'6"
700 mm (28") Shoes	3290 mm	10'10"	3290 mm	10'10"
Bucket Type	HD		HD	
Bucket Capacity	1.76 m ³	2.30 yd ³	1.76 m ³	2.30 yd ³
Bucket Tip Radius	1660 mm	5'5"	1660 mm	5'5"

330 Hydraulic Excavator Specifications

Working Ranges and Forces

All dimensions are approximate and may vary depending on bucket selection.

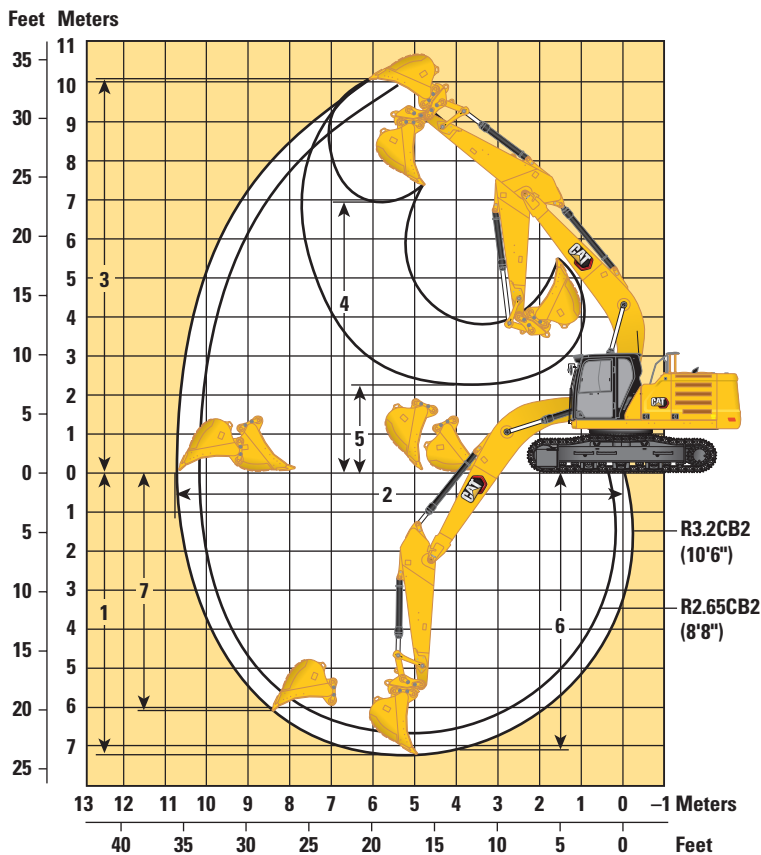

Boom Option

Reach Boom
6.15 m (20'2")

Stick Options

Reach Stick

	R3.2CB2 (10'6")		R2.65CB2 (8'8")	
	mm	ft/in	mm	ft/in
1 Maximum Digging Depth	7240	23'9"	6690	21'11"
2 Maximum Reach at Ground Line	10 680	35'0"	10 210	33'6"
3 Maximum Cutting Height	10 030	32'11"	9920	32'7"
4 Maximum Loading Height	6950	22'10"	6800	22'4"
5 Minimum Loading Height	2300	7'7"	2850	9'4"
6 Maximum Depth Cut for 2440 mm (8 ft) Level Bottom	7090	23'3"	6520	21'5"
7 Maximum Vertical Wall Digging Depth	6010	19'9"	5970	19'7"
Bucket Digging Force (ISO)	179 kN	40,240 lbf	179 kN	40,240 lbf
Stick Digging Force (ISO)	126 kN	28,330 lbf	145 kN	32,600 lbf
Bucket Digging Force (ISO) – Auto Dig Boost	189 kN	42,480 lbf	189 kN	42,480 lbf
Stick Digging Force (ISO) – Auto Dig Boost	133 kN	29,900 lbf	153 kN	34,408 lbf
Bucket Type	HD		HD	
Bucket Capacity	1.76 m ³	2.30 yd ³	1.76 m ³	2.30 yd ³
Bucket Tip Radius	1660 mm	5'5"	1660 mm	5'5"

330 Hydraulic Excavator Specifications

Reach Boom Lift Capacities – Counterweight: 6700 kg (14,770 lb) – without Bucket, Heavy Lift: On

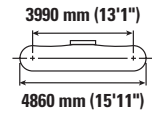
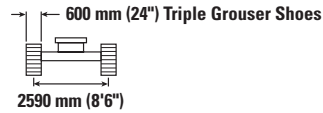
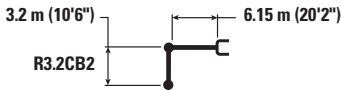

		1500 mm/60 in		3000 mm/120 in		4500 mm/180 in		6000 mm/240 in		7500 mm/300 in		9000 mm/360 in		mm in		
7500 mm 300 in	kg lb													*5600 *12,350	*5600 *12,350	7280 290
6000 mm 240 in	kg lb								*7900 *16,700	6250 13,450				*5350 *11,750	*5350 *11,750	8240 330
4500 mm 180 in	kg lb							*9250 *20,050	8600 18,500	*8400 *18,300	6150 13,200			*5300 *11,650	4750 10,500	8830 350
3000 mm 120 in	kg lb					*14 250 *30,650	12 500 27,000	*10 800 *23,400	8250 17,750	9150 19,650	5950 12,850	*6500 4550		*5450 *11,950	4450 9,750	9140 360
1500 mm 60 in	kg lb					*17 000 *36,700	11 850 25,500	*12 300 *26,550	7900 17,000	8950 19,200	5800 12,450	6800 *13,650	4450 9,600	*5800 *12,700	4350 9,500	9190 370
0 mm 0 in	kg lb					*18 300 *39,550	11 500 24,700	12 250 26,350	7650 16,450	8800 18,900	5650 12,150			*6350 *14,000	4400 9,700	8990 360
-1500 mm -60 in	kg lb	*6950 *15,550	*6950 *15,550	*10 950 *24,800	*10 950 *24,800	*18 250 *39,600	11 400 24,500	12 150 26,050	7550 16,250	8700 18,750	5600 12,000			7300 16,050	4750 10,400	8520 340
-3000 mm -120 in	kg lb	*12 500 *28,000	*12 500 *28,000	*17 650 *40,050	*17 650 *40,050	*17 150 *37,100	11 450 24,650	12 150 26,150	7550 16,250	8750 18,850	5600 12,100			8400 18,600	5400 11,950	7730 310
-4500 mm -180 in	kg lb			*19 900 *42,750	*19 900 *42,750	*14 600 *31,300	11 700 25,150	*10 800 *22,850	7750 16,700					*9500 *20,850	6950 15,550	6510 260

Reach Boom Lift Capacities – Counterweight: 6700 kg (14,770 lb) – without Bucket, Heavy Lift: On

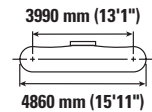
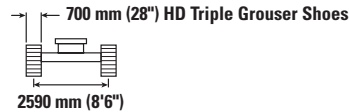
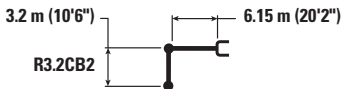

		1500 mm/60 in		3000 mm/120 in		4500 mm/180 in		6000 mm/240 in		7500 mm/300 in		9000 mm/360 in		mm in		
7500 mm 300 in	kg lb													*5600 *12,350	*5600 *12,350	7280 290
6000 mm 240 in	kg lb								*7900 *16,700	6350 13,650				*5350 *11,750	*5350 *11,750	8240 330
4500 mm 180 in	kg lb							*9250 *20,050	8750 18,800	*8400 *18,300	6250 13,400			*5300 *11,650	4850 10,700	8830 350
3000 mm 120 in	kg lb					*14 250 *30,650	12 700 27,400	*10 800 *23,400	8350 18,000	*9150 *19,900	6050 13,050	*6500 4600		*5450 *11,950	4500 9,950	9140 360
1500 mm 60 in	kg lb					*17 000 *36,700	12 000 25,900	*12 300 *26,550	8000 17,250	9100 19,550	5900 12,650	6950 *13,650	4550 9,750	*5800 *12,700	4400 9,700	9190 370
0 mm 0 in	kg lb					*18 300 *39,550	11 700 25,100	12 450 26,800	7750 16,750	8950 19,200	5750 12,350			*6350 *14,000	4500 9,850	8990 360
-1500 mm -60 in	kg lb	*6950 *15,550	*6950 *15,550	*10 950 *24,800	*10 950 *24,800	*18 250 *39,600	11 600 24,900	12 350 26,550	7650 16,500	8850 19,050	5650 12,200			*7350 *16,250	4800 10,600	8520 340
-3000 mm -120 in	kg lb	*12 500 *28,000	*12 500 *28,000	*17 650 *40,050	*17 650 *40,050	*17 150 *37,100	11 650 25,050	12 350 26,600	7700 16,550	8900 19,200	5700 12,350			8550 18,900	5500 12,200	7730 310
-4500 mm -180 in	kg lb			*19 900 *42,750	*19 900 *42,750	*14 600 *31,300	11 850 25,550	*10 800 *22,850	7850 16,950					*9500 *20,850	7050 15,850	6510 260



ISO 10567:2007



* Indicates that the load is limited by hydraulic lifting capacity rather than tipping load. The above loads are in compliance with hydraulic excavator lift capacity standard ISO 10567:2007. They do not exceed 87% of hydraulic lifting capacity or 75% of tipping load. Weight of all lifting accessories must be deducted from the above lifting capacities. Lifting capacities are based on the machine standing on a firm, uniform supporting surface. The use of a work tool attachment point to handle/lift objects, could affect the machine lift performance.

Lift capacity stays with ±5% for all available track shoes.

Always refer to the appropriate Operation and Maintenance Manual for specific product information.

330 Hydraulic Excavator Specifications

Reach Boom Lift Capacities – Counterweight: 6700 kg (14,770 lb) – without Bucket, Heavy Lift: On

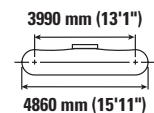
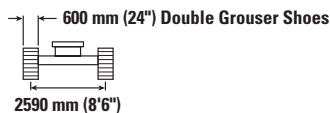
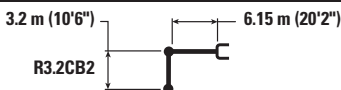

		1500 mm/60 in		3000 mm/120 in		4500 mm/180 in		6000 mm/240 in		7500 mm/300 in		9000 mm/360 in		mm in		
7500 mm 300 in	kg lb													*5600 *12,350	*5600 *12,350	7280 290
6000 mm 240 in	kg lb									*7900 *16,700	6300 13,550			*5350 *11,750	*5350 *11,750	8240 330
4500 mm 180 in	kg lb							*9250 *20,050	8650 18,700	*8400 *18,300	6200 13,350			*5300 *11,650	4800 10,600	8830 350
3000 mm 120 in	kg lb					*14 250 *30,650	12 650 27,250	*10 800 *23,400	8300 17,900	*9150 *19,850	6000 12,950	*6500 4600		*5450 *11,950	4500 9,850	9140 360
1500 mm 60 in	kg lb					*17 000 *36,700	11 950 25,700	*12 300 *26,550	7950 17,150	9000 19,400	5850 12,550	6900 *13,650	4500 9,700	*5800 *12,700	4400 9,600	9190 370
0 mm 0 in	kg lb					*18 300 *39,550	11 600 24,950	12 400 26,600	7700 16,600	8850 19,050	5700 12,250			*6350 *14,000	4450 9,800	8990 360
-1500 mm -60 in	kg lb	*6950 *15,550	*6950 *15,550	*10 950 *24,800	*10 950 *24,800	*18 250 *39,600	11 500 24,750	12 250 26,350	7600 16,400	8800 18,900	5650 12,150			7350 16,250	4750 10,500	8520 340
-3000 mm -120 in	kg lb	*12 500 *28,000	*12 500 *28,000	*17 650 *40,050	*17 650 *40,050	*17 150 *37,100	11 550 24,900	12 300 26,400	7650 16,450	8850 19,050	5650 12,250			8500 18,800	5450 12,100	7730 310
-4500 mm -180 in	kg lb			*19 900 *42,750	*19 900 *42,750	*14 600 *31,300	11 800 25,400	*10 800 *22,850	7800 16,850					*9500 *20,850	7000 15,700	6510 260

Reach Boom Lift Capacities – Counterweight: 6700 kg (14,770 lb) – without Bucket, Heavy Lift: On

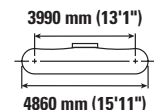
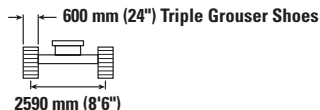
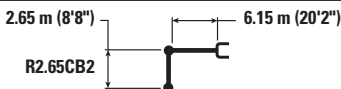

		3000 mm/120 in		4500 mm/180 in		6000 mm/240 in		7500 mm/300 in		mm in										
7500 mm 300 in	kg lb											*7300 *16,200	*7300 *16,200	6680 260						
6000 mm 240 in	kg lb											*8900 *19,450	8800 18,900	*8350 *15,800	6200 13,250	*6900 *15,200	5900 13,150	7710 310		
4500 mm 180 in	kg lb											*12 300 *26,400	*12 300 *26,400	*10 050 *21,750	8500 18,300	*8950 *19,600	6100 13,100	*6800 *14,950	5200 11,450	8340 330
3000 mm 120 in	kg lb											*15 550 *33,350	12 300 26,550	*11 500 *24,850	8150 17,600	9100 19,600	5950 12,800	*6950 *15,350	4800 10,600	8670 340
1500 mm 60 in	kg lb											*16 900 *38,500	11 750 25,250	12 500 26,850	7850 16,900	8950 19,200	5800 12,450	7150 15,750	4700 10,300	8720 350
0 mm 0 in	kg lb											*18 000 *40,100	11 500 24,750	12 250 26,400	7650 16,500	8800 18,950	5700 12,200	7350 16,200	4800 10,550	8510 340
-1500 mm -60 in	kg lb	*10 650 *24,350	*10 650 *24,350	*18 000 *39,050	11 500 24,700	12 200 26,250	7600 16,400	8800 18,900	5650 12,200					8000 17,700	5200 11,450	8010 320				
-3000 mm -120 in	kg lb	*19 950 *45,500	*19 950 *45,500	*16 400 *35,550	11 600 25,000	12 300 26,400	7650 16,550							9450 21,000	6100 13,500	7170 280				
-4500 mm -180 in	kg lb			*13 100 *27,950	11 900 25,650									*9550 *20,950	8300 18,600	5820 230				



ISO 10567:2007



* Indicates that the load is limited by hydraulic lifting capacity rather than tipping load. The above loads are in compliance with hydraulic excavator lift capacity standard ISO 10567:2007. They do not exceed 87% of hydraulic lifting capacity or 75% of tipping load. Weight of all lifting accessories must be deducted from the above lifting capacities. Lifting capacities are based on the machine standing on a firm, uniform supporting surface. The use of a work tool attachment point to handle/lift objects, could affect the machine lift performance.









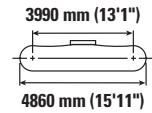
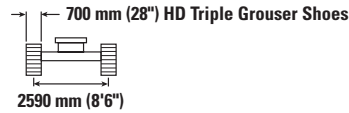
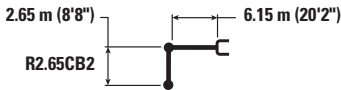

Lift capacity stays with ±5% for all available track shoes.

Always refer to the appropriate Operation and Maintenance Manual for specific product information.

330 Hydraulic Excavator Specifications









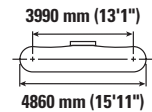
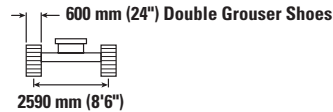
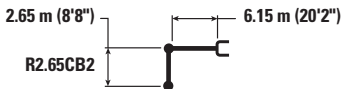

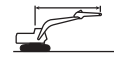
Reach Boom Lift Capacities – Counterweight: 6700 kg (14,770 lb) – without Bucket, Heavy Lift: On



		3000 mm/120 in		4500 mm/180 in		6000 mm/240 in		7500 mm/300 in				mm in
												
7500 mm 300 in	kg lb					*19,100	*19,100			*7300 *16,200	*7300 *16,200	6680 260
6000 mm 240 in	kg lb					*8900 *19,450	8900 19,150	*8350 *15,800	6300 13,450	*6900 *15,200	6000 13,400	7710 310
4500 mm 180 in	kg lb			*12 300 *26,400	*12 300 *26,400	*10 050 *21,750	8650 18,600	*8950 *19,600	6200 13,350	*6800 *14,950	5250 11,650	8340 330
3000 mm 120 in	kg lb			*15 550 *33,350	12 500 26,950	*11 500 *24,850	8300 17,850	9250 19,900	6050 13,000	*6950 *15,350	4900 10,750	8670 340
1500 mm 60 in	kg lb			*16 900 *38,500	11 900 25,700	12 700 27,300	8000 17,200	9100 19,550	5900 12,650	7300 16,050	4750 10,500	8720 350
0 mm 0 in	kg lb			*18 000 *40,100	11 700 25,200	12 500 26,850	7800 16,800	8950 19,300	5750 12,450	7500 16,500	4900 10,750	8510 340
-1500 mm -60 in	kg lb	*10 650 *24,350	*10 650 *24,350	*18 000 *39,050	11 700 25,150	12 400 26,700	7750 16,650	8950 19,250	5750 12,400	8150 18,000	5300 11,650	8010 320
-3000 mm -120 in	kg lb	*19 950 *45,500	*19 950 *45,500	*16 400 *35,550	11 800 25,400	*12 450 *26,850	7800 16,800			9650 21,400	6200 13,700	7170 280
-4500 mm -180 in	kg lb			*13 100 *27,950	12 100 26,050					*9550 *20,950	8400 18,900	5820 230

Reach Boom Lift Capacities – Counterweight: 6700 kg (14,770 lb) – without Bucket, Heavy Lift: On



		3000 mm/120 in		4500 mm/180 in		6000 mm/240 in		7500 mm/300 in				mm in
												
7500 mm 300 in	kg lb					*19,100	*19,100			*7300 *16,200	*7300 *16,200	6680 260
6000 mm 240 in	kg lb					*8900 *19,450	8850 19,050	*8350 *15,800	6250 13,400	*6900 *15,200	6000 13,300	7710 310
4500 mm 180 in	kg lb			*12 300 *26,400	*12 300 *26,400	*10 050 *21,750	8600 18,500	*8950 *19,600	6150 13,250	*6800 *14,950	5250 11,550	8340 330
3000 mm 120 in	kg lb			*15 550 *33,350	12 400 26,800	*11 500 *24,850	8250 17,750	9200 19,750	6000 12,900	*6950 *15,350	4850 10,700	8670 340
1500 mm 60 in	kg lb			*16 900 *38,500	11 850 25,500	12 600 27,100	7950 17,100	9000 19,400	5850 12,600	7250 15,950	4750 10,400	8720 350
0 mm 0 in	kg lb			*18 000 *40,100	11 600 25,000	12 400 26,650	7750 16,700	8900 19,150	5750 12,350	7450 16,400	4850 10,650	8510 340
-1500 mm -60 in	kg lb	*10 650 *24,350	*10 650 *24,350	*18 000 *39,050	11 600 24,950	12 350 26,500	7700 16,550	8850 19,100	5700 12,300	8100 17,850	5250 11,550	8010 320
-3000 mm -120 in	kg lb	*19 950 *45,500	*19 950 *45,500	*16 400 *35,550	11 700 25,200	12 400 26,650	7750 16,700			9550 21,200	6150 13,600	7170 280
-4500 mm -180 in	kg lb			*13 100 *27,950	12 000 25,850					*9550 *20,950	8350 18,800	5820 230



ISO 10567:2007



* Indicates that the load is limited by hydraulic lifting capacity rather than tipping load. The above loads are in compliance with hydraulic excavator lift capacity standard ISO 10567:2007. They do not exceed 87% of hydraulic lifting capacity or 75% of tipping load. Weight of all lifting accessories must be deducted from the above lifting capacities. Lifting capacities are based on the machine standing on a firm, uniform supporting surface. The use of a work tool attachment point to handle/lift objects, could affect the machine lift performance.

Lift capacity stays with ±5% for all available track shoes.

Always refer to the appropriate Operation and Maintenance Manual for specific product information.

330 Hydraulic Excavator Specifications

Bucket Specifications and Compatibility

	Linkage	Width		Capacity		Weight		Fill %	Reach Boom	
		mm	in	m ³	yd ³	kg	lb		R3.2 (10'6")	R2.65 (8'8")
Pin-On (No Quick Coupler)										
General Duty	CB	600	24	0.52	0.68	659	1,454	100	●	●
	CB	750	30	0.71	0.93	726	1,601	100	●	●
	CB	1000	40	1.03	1.35	835	1,841	100	●	●
	CB	1350	54	1.54	2.02	1005	2,216	100	●	●
	CB	1500	60	1.76	2.30	1069	2,357	100	●	●
Heavy Duty	CB	1600	63	1.86	2.43	1099	2,423	100	X	X
	CB	1200	48	1.33	1.74	1096	2,417	100	●	●
Heavy Duty	CB	1350	54	1.54	2.02	1196	2,637	100	●	●
	CB	1450	57	1.60	2.09	1274	2,809	100	●	●
Heavy Duty	CB	1600	63	1.80	2.36	1348	2,973	100	X	X
	CB	1500	60	1.76	2.30	1391	3,067	100	⊙	●
Maximum load with pin-on (payload + bucket)								kg	4605	5045
								lb	10,152	11,122
With Pin Grabber Quick Coupler										
General Duty	CB	600	24	0.52	0.68	659	1,454	100	●	●
	CB	750	30	0.71	0.93	726	1,601	100	●	●
	CB	1000	40	1.03	1.35	835	1,841	100	●	●
	CB	1350	54	1.54	2.02	1005	2,216	100	⊙	●
	CB	1500	60	1.76	2.30	1069	2,357	100	⊙	⊙
Heavy Duty	CB	1600	63	1.86	2.43	1099	2,423	100	⊖	⊙
	CB	1200	48	1.33	1.74	1096	2,417	100	●	●
Heavy Duty	CB	1350	54	1.54	2.02	1196	2,637	100	⊙	●
	CB	1450	57	1.60	2.09	1274	2,809	100	⊙	●
Heavy Duty	CB	1600	63	1.80	2.36	1348	2,973	100	⊖	⊙
	CB	1500	60	1.76	2.30	1391	3,067	100	⊖	⊙
Maximum load with coupler (payload + bucket)								kg	4079	4519
								lb	8,992	9,962

The above loads are in compliance with hydraulic excavator standard EN474-5:2006+A3:2013, they do not exceed 87% of hydraulic lifting capacity or 75% of tipping capacity with front linkage fully extended at ground line with bucket curled.

Capacity based on ISO 7451:2007.

Bucket weight with General Duty tips.

Maximum Material Density:

- 2100 kg/m³ (3,500 lb/yd³)
- ⊙ 1800 kg/m³ (3,000 lb/yd³)
- ⊖ 1500 kg/m³ (2,500 lb/yd³)
- X Not Recommended

Caterpillar recommends using appropriate work tools to maximize the value customers receive from our products. Use of work tools, including buckets, which are outside of Caterpillar's recommendations or specifications for weight, dimensions, flows, pressures, etc. may result in less-than-optimal performance, including but not limited to reductions in production, stability, reliability, and component durability. Improper use of a work tool resulting in sweeping, prying, twisting and/or catching of heavy loads will reduce the life of the boom and stick.

330 Hydraulic Excavator Specifications

Attachments Offering Guide

Not all Attachments are available in all regions. Consult your Cat dealer for configurations available in your region.

Match

* Working range front only

No Match

PIN-ON ATTACHMENTS

Boom Type		Reach	Reach
Stick Length		R3.2 (10'6")	R2.65 (8'8")
Hydraulic Hammers	H120 S	✓	✓
	H130 GC	✓	✓
	H130 GC S	✓	✓
	H130 S	✓	✓
	H140 GC	✓	✓
	H140 GC S	✓	✓
	H140 S	✓	✓
	H160 GC	✓	✓
	H160 GC S	✓	✓
	H160 S	✓	✓
Demolition and Sorting Grapples	G324	✓	✓
	G332	✓	✓
Mobile Scrap and Demolition Shears	S3025 Flat Top	✓	✓
	S3035 Flat Top	✓	✓
Pulverizers	P224 Secondary Pulverizer	✓	✓
Mulchers	HM5515	✓	✓
	HM6015	✓	✓
Compactors (Vibratory Plate)	CVP110	✓	✓
Rotary Cutters	RC20	✓	✓
	RC30	✓	✓

CAT PIN GRABBER COUPLER ATTACHMENTS

Boom Type		Reach	Reach
Stick Length		R3.2 (10'6")	R2.65 (8'8")
Hydraulic Hammers	H120 S	✓	✓
	H130 GC	✓	✓
	H130 GC S	✓	✓
	H130 S	✓	✓
	H140 GC	✓	✓
	H140 GC S	✓	✓
	H140 S	✓	✓
	H160 GC	✓	✓
	H160 GC S	✓	✓
	H160 S	✓	✓†
Demolition and Sorting Grapples	G324	✓	✓†
	G332	✓	✓†
Mobile Scrap and Demolition Shears	S3025 Flat Top	✓	✓
	S3035 Flat Top	✓	✓
Pulverizers	P224 Secondary Pulverizer	✓	✓
Mulchers	HM5515	✓	✓
	HM6015	✓	✓
Compactors (Vibratory Plate)	CVP110	✓	✓
Rotary Cutters	RC20	✓	✓
	RC30	✓	✓

(continued on next page)

330 Hydraulic Excavator Specifications

Attachments Offering Guide *(continued)*

Not all Attachments are available in all regions. Consult your Cat dealer for configurations available in your region.

Match

TRS23 (PIN-ON TOP/S70 BOTTOM) ATTACHMENTS

Some attachments require more hydraulic flow and are best suited with a machine that has HP2 circuits and a tiltrotator with a high flow swivel. Check the hydraulic capability of your machine and tiltrotator and the requirements of your attachment to ensure a proper match.

Boom Type		Reach	Reach
Stick Length		R3.2 (10'6")	R2.65 (8'8")
Hydraulic Hammers	H120 S	✓	✓
	H130 S	✓	✓
Compactors (Vibratory Plate)	CVP110	✓	✓

NOTE: Use hammers on tiltrotators less than 10% of working hours per year or maximum 200 hours per year. Refer to your Operation and Maintenance Manual for recommended hydraulic flow requirements.

TRS23 (PIN-ON TOP/S80 BOTTOM) ATTACHMENTS

Some attachments require more hydraulic flow and are best suited with a machine that has HP2 circuits and a tiltrotator with a high flow swivel. Check the hydraulic capability of your machine and tiltrotator and the requirements of your attachment to ensure a proper match.

Boom Type		Reach	Reach
Stick Length		R3.2 (10'6")	R2.65 (8'8")
Hydraulic Hammers	H120 S	✓	✓
	H130 GC S	✓	✓
	H130 S	✓	✓
Compactors (Vibratory Plate)	CVP110	✓	✓

NOTE: Use hammers on tiltrotators less than 10% of working hours per year or maximum 200 hours per year. Refer to your Operation and Maintenance Manual for recommended hydraulic flow requirements.

BOOM-MOUNT ATTACHMENTS

Boom Type		Reach
Mobile Scrap and Demolition Shears	S3050 Flat Top	✓

330 Standard and Optional Equipment

Standard and Optional Equipment

Standard and optional equipment may vary. Consult your Cat dealer for details.

	Standard	Optional		Standard	Optional
CAB			CAT TECHNOLOGY		
ROPS	✓		Cat Equipment Management:		
OPG		✓	– VisionLink®	✓ ¹	
High-resolution 254 mm (10") LCD touchscreen monitor	✓		– VisionLink Productivity		✓ ²
Auto bi-level air conditioner	✓		– Remote Flash	✓	
Jog dial and shortcut keys for monitor control	✓		– Remote Troubleshoot	✓	
Keyless push-to-start engine control	✓		– Work tool recognition and tracking (PL161)	✓	
Height-adjustable console	✓		– Operator Coaching		✓ ³
Tilt-up left-side console	✓		Cat Grade:		
Heated air-suspension seat	✓		– Cat Grade with 2D	✓	
51 mm (2") seat belt	✓		– Cat Grade with 2D with Attachment Ready Option (ARO)		✓
Monitor integrated Bluetooth® radio with USB/Auxiliary ports	✓		– Laser catcher		✓
12V DC outlets	✓		– Cat Grade with 3D (single or dual GNSS)		✓
Document storage	✓		– Compatible with 3D grade systems from Trimble, Topcon, and Leica	✓	
Overhead storage and rear storage with nets	✓		– Cat Grade 3D Ready		✓
Beverage holder	✓		– Cat Grade Connectivity		✓ ²
Cup holder	✓		Cat Assist:		
Openable two-piece front window	✓		– Grade Assist	✓	
Rear window emergency exit	✓		– Boom Assist	✓	
Radial wiper with washer	✓		– Bucket Assist	✓	
Openable polycarbonate skylight hatch	✓		– Swing Assist	✓	
LED dome light	✓		– Lift Assist	✓	
Floor welcome light	✓		Cat Payload:		
Roof sunscreen	✓		– On-the-go weighing	✓	
Roller front sunscreen	✓		– Semiautomatic calibration	✓	
Roller rear sunscreen		✓	– Payload/cycle information	✓	
Washable floor mat	✓		– VisionLink Productivity back office reporting		✓ ²
Beacon ready	✓		Cat Advanced Payload:		
Cat Stick Steer		✓	– Daily totals		✓
Auxiliary relay		✓	– Custom lists		✓
			– Smart weight target		✓
			– E-ticket Integration		✓ ²
			Other:		
			Cat Tiltrotator (TRS) integration		✓

¹Provides core telematics data to manage health, maintenance insights, and condition monitoring. Other plans available for more comprehensive data reporting. Consult your Cat dealer for details.

²VisionLink subscription required. Consult your Cat dealer for details.

³VisionLink subscription required for back office reporting. Consult your Cat dealer for details.

(continued on next page)

Standard and Optional Equipment *(continued)*

Standard and optional equipment may vary. Consult your Cat dealer for details.

	Standard	Optional		Standard	Optional
ENGINE			BOOM, STICKS AND LINKAGES		
Cat® C7.1 twin turbo diesel engine	✓		6.15 m (20'2") Reach boom	✓	
Three selectable modes: Power, Smart, Eco	✓		3.2 m (10'6") Reach stick		✓
Automatic engine speed control	✓		2.65 m (8'8") Reach stick		✓
Automatic engine idle-shutdown	✓		Bucket Linkage, CB2 family with lifting eye, Cat Grade	✓	
4500 m (14,760 ft) altitude capability with engine power derate above 3000 m (9,840 ft)	✓		UNDERCARRIAGE AND STRUCTURES		
50° C (122° F) high-ambient cooling capability with derate	✓		Full-length track guiding guards		✓
-18° C (0° F) cold start capability	✓		Segmented track guiding guards	✓	
2 × 115 amp dual alternator	✓		Swivel guard	✓	
Sealed double element air filter with integrated pre-cleaner	✓		Bottom guard		✓
Two-stage fuel filtration with water separator and indicator	✓		HD bottom guard		✓
Electric fuel priming pump	✓		HD travel motor guard	✓	
Electric cooling fans with auto-reverse function	✓		Grease lubricated track	✓	
HYDRAULIC SYSTEM			Swing drive and motor, and swing bearing for higher swing torque	✓	
Electronic main control valve	✓		Base frame with HD rollers	✓	
Electric boom regeneration circuit	✓		Tie-down points on base frame	✓	
Stick regeneration circuit	✓		6700 kg (14,770 lb) counterweight	✓	
Automatic hydraulic oil warm up	✓		600 mm (24") triple grouser track shoes		✓
Automatic two-speed travel	✓		600 mm (24") double grouser track shoes		✓
Boom and stick drift reduction valve	✓		700 mm (28") triple grouser HD track shoes		✓
Boom lowering check valve	✓		<i>(continued on next page)</i>		
Stick lowering check valve	✓				
Auto Dig Boost	✓				
Auto heavy lift	✓				
High performance hydraulic return filter	✓				
Final drive with bio hydraulic oil capable travel motor	✓				
Fine swing control	✓				
Hammer return filter circuit		✓			
Advanced Tool Control (two pump, one/two way high-pressure flow)		✓			
Hydraulic efficiency monitoring		✓			
Medium-pressure circuit		✓			
Common Quick Coupler Circuit for Cat Pin Grabber and CW Dedicated	✓				
Electronic Pattern Changer (requires activation)	✓				

330 Standard and Optional Equipment

Standard and Optional Equipment (continued)

Standard and optional equipment may vary. Consult your Cat dealer for details.

	Standard	Optional		Standard	Optional
ELECTRICAL SYSTEM			SAFETY AND SECURITY		
Maintenance-free 1,000 CCA batteries (×2)	✓		Cat Command (remote control)		✓
Programmable time-delay LED working lights	✓		2D E-Fence:	✓	
Centralized electrical disconnect switch	✓		– E-ceiling		
LED chassis light, Left Hand (LH) and Right Hand (RH) boom lights, cab lights	✓		– E-floor		
Premium surround lighting package		✓	– E-swing		
SERVICE AND MAINTENANCE			– E-wall		
Grouped location of engine oil and fuel filters	✓		– E-cab avoidance		
Ground-level second dipstick for engine oil	✓		Auto hammer stop	✓	
Side entry to service platform	✓		Rearview camera	✓	
Scheduled Oil Sampling (S·O·S SM) ports	✓		Right-hand-sideview camera	✓	
QuickEvac TM maintenance ready		✓	360° visibility		✓
Radiator screen		✓	Secure start with PIN code	✓	
Integrated vehicle health management system	✓		Caterpillar One Key security system	✓	
			Lockable external tool/storage box	✓	
			Lockable door, fuel, and hydraulic tank locks	✓	
			Lockable fuel drain compartment	✓	
			Service platform with anti-skid plate and recessed bolts	✓	
			RH handrail and hand hold	✓	
			Cab mirror for RH track edge	✓	
			Signaling/warning horn	✓	
			Swing alarm		✓
			Ground-level secondary engine shutoff switch in cab	✓	
			Hydraulic lock out lever that neutralizes all controls	✓	
			Lockable disconnect switch	✓	
			Travel alarm	✓	
			Inspection lighting		✓

Dealer Installed Kits and Attachments

Attachments may vary. Consult your Cat dealer for details.

CAB

- RH electrical pedal (two-way) for tool control
- Radial lower wiper for two piece (70/30) windshield, with washer
- Rain protector plus cab light cover
- 75 mm (3") retractable seat belt

SAFETY AND SECURITY

- Cat Detect – People Detection
- Cat Command – Remote control kit
- Seat belt indicator
- Bluetooth receiver
- Bluetooth key fob

GUARDS

- Side rubber bumper guard
- Operator Protective Guards (not compatible with cab light cover, rain protector)
- Mesh guard full front (not compatible with cab light cover, rain protector)
- Full protecting vandalism guard (not compatible with cab light cover, rain protector)

ELECTRICAL

- Jump start wiring

SERVICE AND MAINTENANCE

- Grease gun holder

330 Environmental Declaration

The following information applies to the machine at the time of final manufacture as configured for sale in the regions covered in this document. The content of this declaration is valid as of the date issued; however, content related to machine features and specifications are subject to change without notice. For additional information, please see the machine's Operation and Maintenance Manual.

For more information on sustainability in action and our progress, please visit <https://www.caterpillar.com/en/company/sustainability>.

Engine

- The Cat® C7.1 engine meets U.S. EPA Tier 4 Final, EU Stage V, Korea Stage V, and Japan 2014 emission standards.
- Cat diesel engines are required to use ULSD (ultra-low sulfur diesel fuel with 15 ppm of sulfur or less) or ULSD blended with the following lower-carbon intensity fuels** up to:
 - ✓ 20% biodiesel FAME (fatty acid methyl ester)*
 - ✓ 100% renewable diesel, HVO (hydrogenated vegetable oil) and GTL (gas-to-liquid) fuels

Refer to guidelines for successful application. Please consult your Cat dealer or "Caterpillar Machine Fluids Recommendations" (SEBU6250) for details.

**Engines with no aftertreatment devices can use higher blends, up to 100% biodiesel (for use of blends higher than 20% biodiesel, consult your Cat dealer).*

***Tailpipe greenhouse gas emissions from lower-carbon intensity fuels are essentially the same as traditional fuels.*

Air Conditioning System

- The air conditioning system on this machine contains the fluorinated greenhouse gas refrigerant R134a (Global Warming Potential = 1430). The system contains 0.85 kg (1.9 lb) of refrigerant which has a CO₂ equivalent of 1.216 metric tonnes (1.340 tons).

Paint

- Based on best available knowledge, the maximum allowable concentration, measured in parts per million (PPM), of the following heavy metals in paint are:
 - Barium < 0.01%
 - Cadmium < 0.01%
 - Chromium < 0.01%
 - Lead < 0.01%

Sound Performance

ISO 6395:2008 (external) – 103 dB(A)

ISO 6396:2008 (inside cab) – 70 dB(A)

- Hearing protection may be needed when operating with an open operator station and cab (when not properly maintained or doors/windows open) for extended periods or in a noisy environment.

Oils and Fluids

- Caterpillar factory fills with ethylene glycol coolants. Cat Diesel Engine Antifreeze/Coolant (DEAC) and Cat Extended Life Coolant (ELC) can be recycled. Consult your Cat dealer for more information.
- Cat Bio HYDO™ Advanced is an EU Ecolabel approved biodegradable hydraulic oil.
- Additional fluids are likely to be present, please consult the Operations and Maintenance Manual or the Application and Installation guide for complete fluid recommendations and maintenance intervals.

Features and Technology

- The following features and technology may contribute to fuel savings and/or carbon reduction. Features may vary. Consult your Cat dealer for details.
 - Advanced hydraulic systems balance power and efficiency
 - Smart mode matches machine power to digging requirements automatically
 - Eco mode supports reduced fuel consumption for light applications
 - Utilizing Cat technologies can help increase operating efficiencies
 - Extended service intervals help decrease maintenance costs
 - Programmable high-efficiency cooling fans run only when needed
 - The latest hydraulic oil filter provides longer life with a 3,000-hour replacement interval

Recycling

- The materials included in machines are categorized as below with approximate weight percentage. Because of variations of product configurations, the following values in the table may vary.

Material Type	Weight Percentage
Steel	86.85%
Iron	4.63%
Nonferrous Metal	1.55%
Mixed Metal	0.07%
Mixed-Metal and Nonmetal	0.63%
Plastic	1.79%
Rubber	0.16%
Mixed Nonmetallic	0.23%
Fluid	3.12%
Other	0.96%
Uncategorized	0.00%
Total	100%

- A machine with higher recyclability rate will ensure more efficient usage of valuable natural resources and enhance End-of-Life value of the product. According to ISO 16714:2008 (Earthmoving machinery – Recyclability and recoverability – Terminology and calculation method), recyclability rate is defined as percentage by mass (mass fraction in percent) of the new machine potentially able to be recycled, reused or both.

All parts in the bill of material are first evaluated by component type based on a list of components defined by the ISO 16714:2008 and Japan CEMA (Construction Equipment Manufacturers Association) standards. Remaining parts are further evaluated for recyclability based on material type.

Because of variations of product configurations, the following value in the table may vary.

Recyclability – 97%

For more complete information on Cat products, dealer services, and industry solutions, visit us on the web at www.cat.com

© 2024 Caterpillar
All rights reserved

Materials and specifications are subject to change without notice. Featured machines in photos may include additional equipment. See your Cat dealer for available options.

CAT, CATERPILLAR, LET'S DO THE WORK, their respective logos, "Caterpillar Corporate Yellow," the "Power Edge" and Cat "Modern Hex" trade dress as well as corporate and product identity used herein, are trademarks of Caterpillar and may not be used without permission. VisionLink is a trademark of Caterpillar Inc., registered in the United States and in other countries.

AEXQ4007-00 (10-2024)
Build Number: 07H
(Aus-NZ)

